

# Series 2EZ

## *Installation Maintenance Repair Manual*

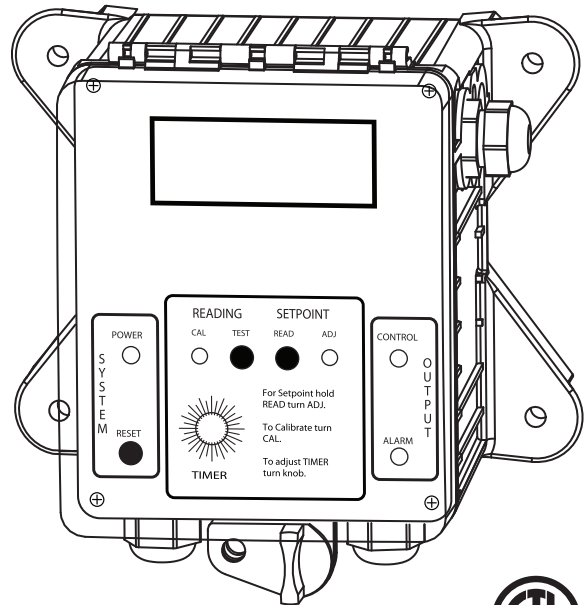

Advantage Controls  
4700 Harold Abitz Dr.  
Muskogee, OK 74403  
Phone: 918-686-6211  
Fax: 888-686-6212  
www.advantagecontrols.com  
email: support@advantagecontrols.com

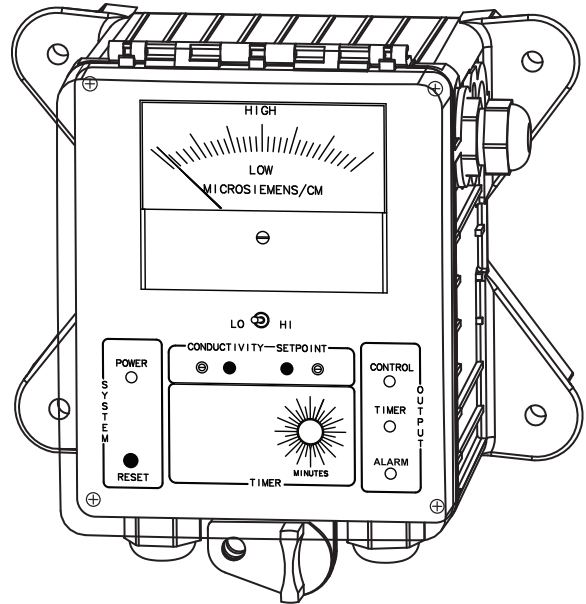

04/2019

# Series 2EZ

## Instruction & Maintenance Manual

### Table of Contents

Contents	Page
I. Introduction.....	3
Model Numbering .....	3
Description of Unit .....	3
Optional Feed Timers .....	4
II. Installation .....	4
Electrical Installation.....	4
Mounting.....	5
Connections.....	5
Electrode Installation .....	7
A. Tower.....	7
B. Boiler .....	9
III. Front Panel Description .....	11
IV. Start Up .....	12
Conductivity Tower .....	12
Conductivity Boiler.....	12
pH / ORP .....	14
V. Maintenance .....	14
Electrode Cleaning Procedures.....	14
VI. Troubleshooting.....	15
VII. Warranty & 30 Day Billing Memo Policy .....	16

# I. Introduction

Series 2EZ controllers are analog style controllers for the control of conductivity, pH, or ORP in recirculating water applications, such as cooling towers, boilers and swimming pools.

## Model Numbering

Standard 2EZ controllers can have one probe input or control function plus several optional features. Your unit may be supplied with one or more of the options that are described in this manual. To determine what features apply to your unit, check the model number label located on the controller enclosure. This list represents our most popular options.

**Example Model: 2EZ-B7M-K**

### Control Functions

- A** Tower conductivity
- B** Boiler conductivity
- P** pH-single set w/ limit
- Q** pH-dual set w/ limit
- R** ORP with limit timer

### Boiler Sample Methods

- 7** Timed Sampling (0-7.75 hr interval)
- 8** Continuous
- 9** Condensate

### Display Type

- L** Digital LCD
- M** Analog Needle Meter

### Flow Switch

- E** Standard Mechanical PVC

### Options

- C** Conduit connection
- C1** 240 volt conduit
- G** Time delay relay output
- K** High/Low Alarm 120 volt and dry contact  
Independent adjustment screws
- O** 4-20mA non-isolated output
- O1** 4-20mA isolated output
- S** Scale options
- W** Additional tower probe wire

### Chemical Feed Timers

(available on 2EZ-A models)

- T0** Omit Limit Timer on pH or ORP models
- T1** Limit Timer 0-90 minutes
- T2** Pulse Timer 0-150 seconds
- T3** Percent Timer
- T4** Post Bleed Timer
- T32** Recycle Timer (timer only unit)

## Description of Unit

The Series 2EZ analog controllers may be configured to control one of four different probe control functions: cooling tower conductivity, boiler conductivity, pH or ORP. Each of these control functions are based on an analog input from a probe and will include user adjustable relay control set point. Each control function will include a control relay output. When the reading reaches the Set Point the control relay is activated until the reading changes by the Differential amount.

1. **Tower Conductivity** - The conductivity function of the controller is designed to continuously monitor and control Total Dissolved Solids (TDS) in a recirculating system like a cooling tower in terms of electrical conductivity measured in MicroSiemens/cm. This control function is also referred to as Bleed.
2. **Boiler Conductivity** - This conductivity also controls in terms of electrical conductivity measured in MicroSiemens/cm. However, the sampling method may be Timed or Continuous based on the option selected.
3. **pH** - The pH function monitors and controls pH on a scale of 0-14 pH (LCD) or 2-12pH (analog).
4. **ORP** - The ORP function monitors and controls ORP on an LCD scale of +/- 999 mV .

## Optional Feed Timers

One of these timer options are available on 2EZ-A tower conductivity models. Check the model numbering information on page 3 and your units model number. The pH and ORP units come standard with a control output limit timer that is activated based on the control setpoint. Recycle Timer is only available as a stand alone timer unit without any probe control function.



1. **Limit Timer** - This timer activates simultaneously with the bleed. The timer limits the amount of time the relay output will be on during a bleed cycle, preventing chemical overfeed. The timer's standard range is 0-93 minutes.
2. **Pulse Timer** - This timer starts when a dry contact is received from a make-up water meter (supplied separately). The timer's standard range is 0-155 seconds.
3. **Percentage** - The feed relay is on for a percentage of a continuously repeating cycle time. The standard timer can be set from 0-100% of a 10 minute cycle time.
4. **Post Bleed** - The feed relay is activated after the bleed is finished for the length of the bleed run time. A limit timer can be set for a maximum run time regardless of the bleed cycle length.
5. **Recycle Timer** - Available as a timer only unit with a 0-15 hr "off" time and 0-155 second run or "on" time. The timer will count down the set "off" time then activate the relay for the set run time and continuously repeat the sequence over: Cycle will equal total of "off" plus "on" time.

## II. Installation

### Electrical Installation

The standard units have a voltage regulated internal power supply capable of operating in the range of approximately 105 to 135 VAC. Use a supply voltage of 110 to 125 VAC for best results. Relay outputs (2.5 amp) and power into logic board (2 amp) are each individually protected by a replaceable fuse.

Prewired units are supplied with a 16 AWG cable with 3-wire grounded USA 120 volt plug for incoming power and 18 AWG 3-wire grounded receptacle cords for all control relay outputs.

 <b>CAUTION</b> 
1. There are live circuits inside the controller even when the power switch on the front panel is in the OFF position. Never open the front panel without first disconnecting power from the outlet. Prewired controllers are supplied with an 8 foot, 18 AWG power cord with USA style plug. A #1 Phillips driver is required to open the front panel.
2. Low voltage signal wires (probes, flow switch, water meter, etc.) should never be run in conduit with high voltage (like 115VAC) wires.
3. Never attempt to land connections to the controller without first disconnecting power from the outlet.
4. Do not block access to disconnect power during mounting and installation.
5. The controller should be connected to its own isolated circuit breaker, and for best results, the ground should be a true earth ground, not shared. Any attempt to bypass the grounding will compromise the safety of users and property.
6. The electrical installation of the controller must be performed by trained personnel only and conform to all applicable National, State and Local codes.
7. Operation of this product in a manner not specified by Advantage Controls may result in damage to equipment or persons.
8. Avoid mounting in locations that expose the controller to direct sunlight, vapors, vibration, liquid spills or extreme temperatures; less than 0°F (-17.8°C) or greater than 120°F (50°C). EMI(electromagnetic interference) from radio transmissions and electric motors can also cause damage or interference and should be avoided.

**Note:**  
Power (line voltage) must be disconnected while making any connections. If power is supplied to the unit, line voltage will be present on the relay cards.

## Mounting

Select a mounting location that provides the operator easy access to the unit and a clear view of the controls through the cover of the controller. The location should be in proximity to grounded electrical connections, the needed sample line plumbing, and on a stable vertical surface.

## Connections

Conduit units are predrilled at the factory and supplied with conduit knockouts for easy hard wiring to supplied connectors located in the back section of the controller. Remove the panel screws for access.

## Dip Switch Settings

Dip switch settings activate various features or functions. The switch has a notation indicating off version.

### Conductivity Card

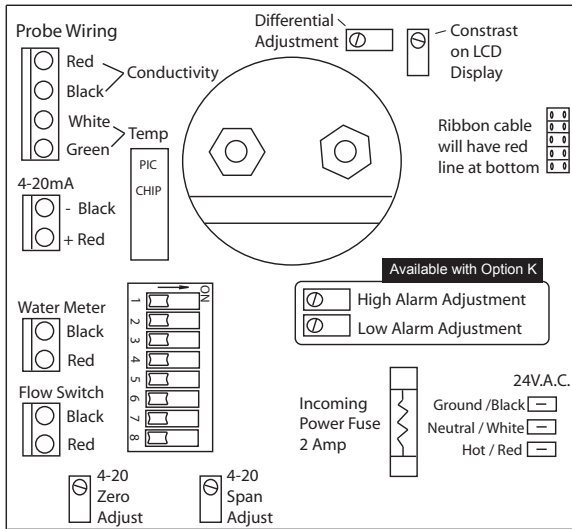

### Conductivity Card Dip Switches

1. **Trip Point Direction**-Off / Rising; On / Falling.
2. **Backlight** -On for backlight on (LCD only).
3. **Flow Switch**-Off no Flow / On for Flow Switch.
4. **Differential**-Off for normal operations. On to show the differential amount on the display (adjust pot shown above to change value).
5. **Alarm Value**-Off for normal operations. On to see High alarm value on the display (press Read while On to see Low alarm value). If Adjustable alarm option is present use Alarm pots shown above to adjust value while ON.

#### 6. 7. For Tower Units Timers

- |     |     |             |
|-----|-----|-------------|
| Off | Off | Pulse Timer |
| On  | Off | Percent     |
| Off | On  | Limit       |
| On  | On  | Post Bleed  |

#### 6. 7. For Boiler Units Sampling

- |     |     |                                 |
|-----|-----|---------------------------------|
| Off | Off | Continuous                      |
| On  | Off | Sample & Hold                   |
| Off | On  | Timed with 0-7.75 hour Interval |

8. **Boiler Sample & Hold**-Off for normal operation timers on front set Interval and Duration. On to use timers to set Hold and Blowdown (interval knob = blowdown and duration knob = holdtime).

### pH / ORP Card

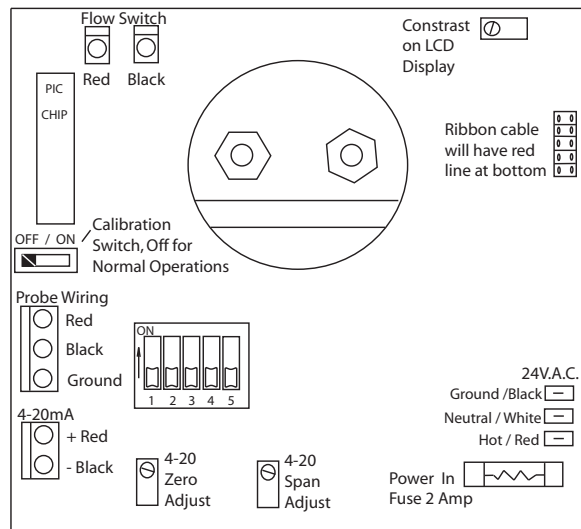

### pH / ORP Card Dip Switches

1. **Trip Point Direction**-Off / Rising; On / Falling.
2. **Backlight** -On for backlight on (LCD only).
3. **Flow Switch**-Off no Flow / On for Flow Switch.
4. **pH Second Trip Point Direction**-Off for Falling and ON for rising for dual set point units.
5. **Alarm Value**-See #5 in left column for units with adjustable alarm option (pots on front panel).

#### Note:

To change the **differential setting** hold both the *set point* and *reset button* while adjusting the differential pot.

# 2EZ Wiring Addendum

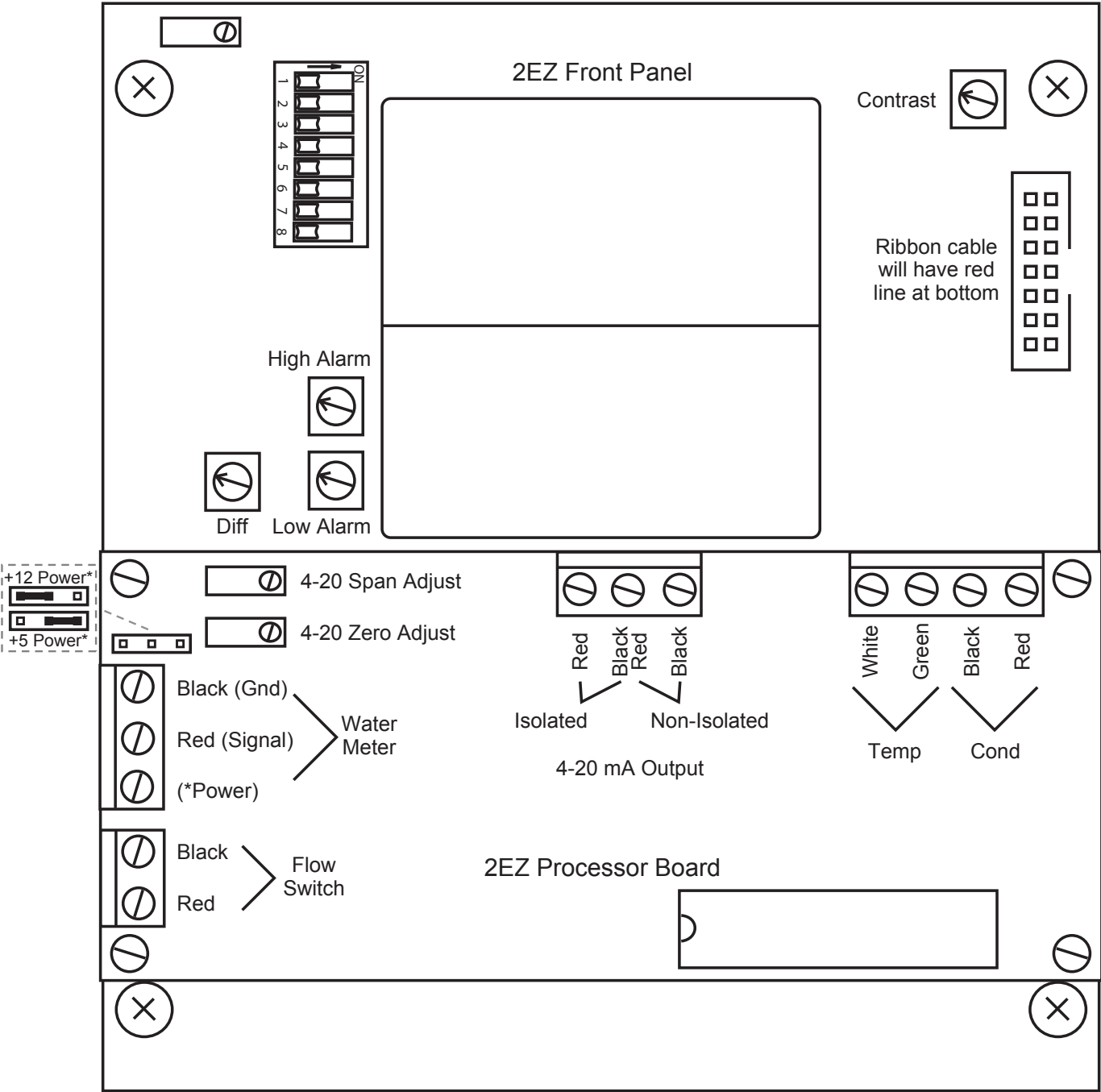

## Boiler Controller Connections (additional):

With the control box mounted in a convenient location remove the 4 screws from the lower section of the enclosure. Then using a flat screwdriver blade, pop panel loose from the control box, from the right side. This will expose the terminal connections in the bottom of the box.

### Typical Blowdown Valve Connection

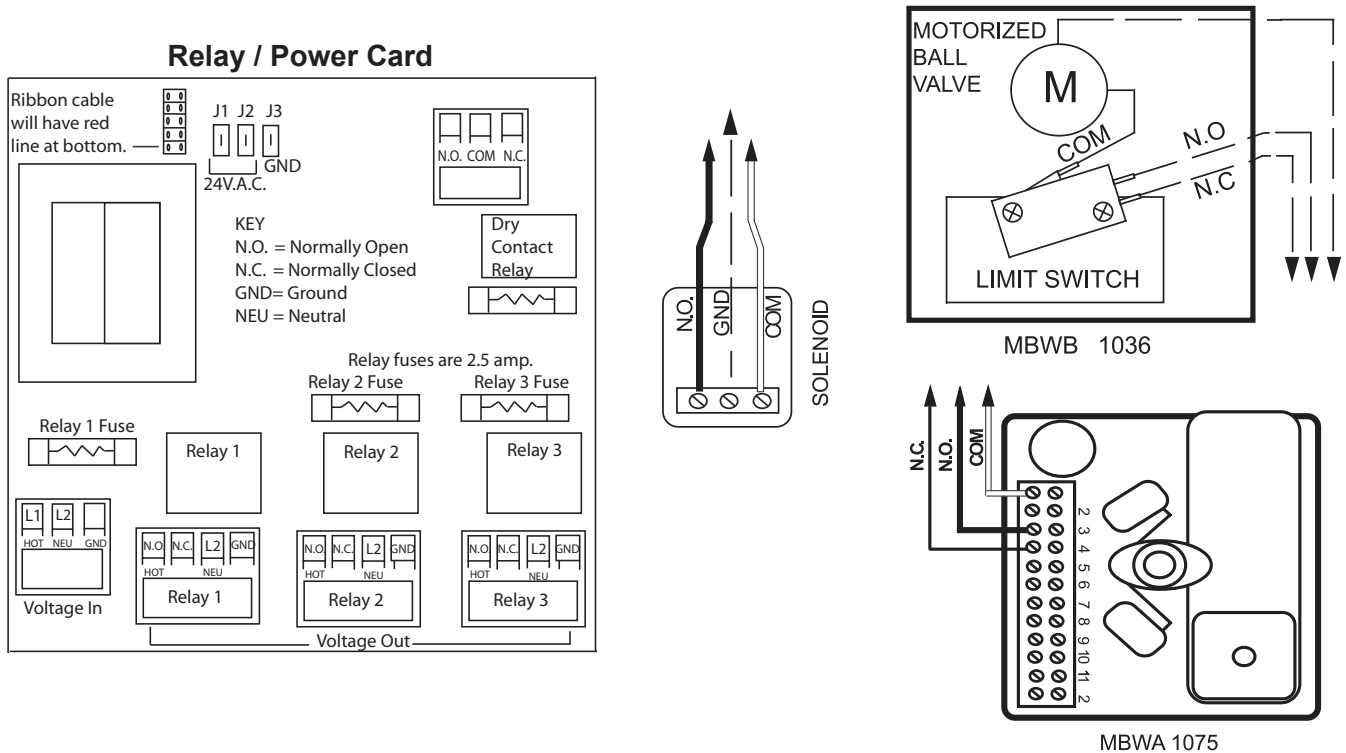

## Electrode Installation

2EZ controllers may come configured for various circulating water systems. Listed below are instructions for typical cooling tower conductivity, pH and ORP plus boiler conductivity installations. Your specific installation requirements may differ but should conform to these instructions as much as possible for proper operation.

### A. Cooling Tower

The standard probe(s) and/or flow assembly for cooling tower installations is constructed of schedule 80 PVC and supplied with 3/4" slip fittings for installing into a sample line. To insure proper operation the sample line must have a flow rate of 3-10 gpm. Inlet pressure must be higher than outlet pressure in order for water to flow past the electrode(s). The conductivity tower probes are temperature compensated for increased accuracy.

#### NOTES:

1. Install an isolation valve on either side of the flow assembly so probes can be easily removed for maintenance.
2. A line strainer is recommended upstream to protect against fouling.
3. Units with a flow switch require the needed flow rate of 3-10 gpm to operate the relay outputs.



#### WARNINGS:

1. Probes are O-ring sealed, which if damaged will cause a leak.
2. Do not exceed a water temperature range of 32°F to 140°F.
3. Do not exceed a maximum pressure of 150 psi (100 psi for pH/ORP).

## Typical Tower Installation

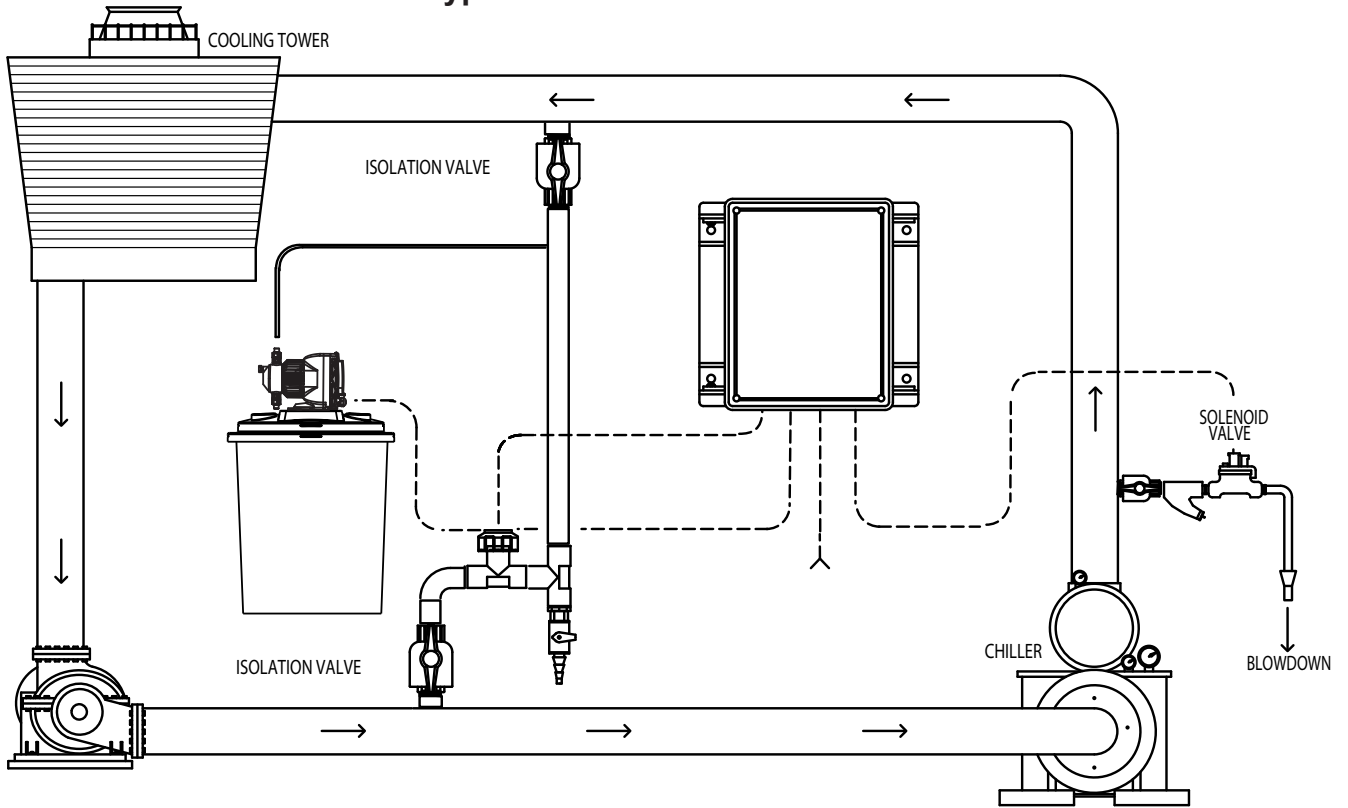

## Typical Tower Probes

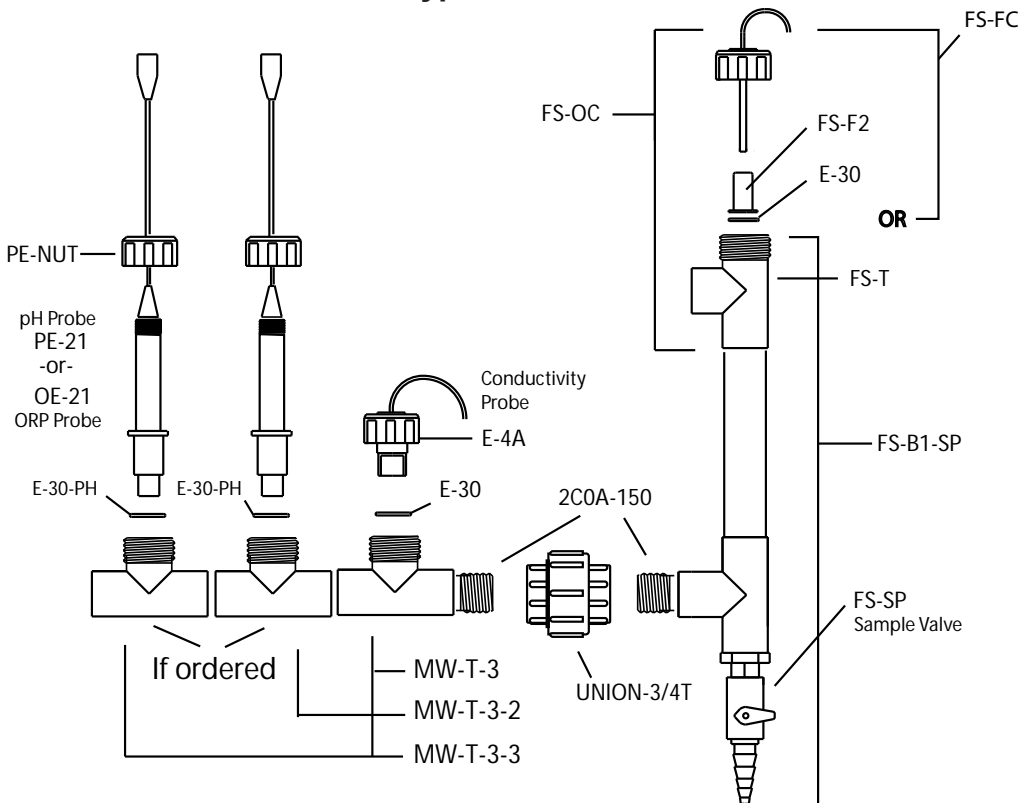



## B. Boiler

Standard boiler probes (part # BE-1C) are built in a 1" MNPT stainless steel bushing and are supplied with a 1" FNPT cross designed for mounting in the skimmer (surface) blowdown line. Sampling of the boiler's water can be achieved using one of two typical plumbing configurations (continuous sampling or timed and/or hold sampling). For a successful installation, it is critical to observe the recommended distances and pipe sizes provided in the installation drawings. For best results, the electrode cross should be mounted on a 1" skimmer blowdown line within 4' of the boiler. Smaller line sizes and greater distances may affect the response time and accuracy of the electrode. A flow-throttling device down stream from the probe (within 24 inches) is required to ensure that the electrode is exposed to water and not steam. Properly installed and adjusted, this device will prevent flashing in the electrode chamber.

### NOTES:

1. Install a fully ported type valve between the electrode and the boiler. This allows the electrode to be isolated for removal and cleaning.
2. A flushing line and 1/4 turn type ball valve should be installed in the bottom of the cross to periodically "flush" sediment from the electrode chamber.
3. Make sure the alignment arrows on the probe end up parallel to the flow for best performance.



### WARNINGS:

1. The probe must be fully immersed in the system water to read correctly. Steam flashing will result in incorrect readings.
2. Do not exceed a maximum water temperature of 400°F.
3. Do not exceed a maximum pressure of 250 psi.
4. A throttling device must be installed down stream from the probe.

## Typical Boiler Probes

BE-1 Conductivity Probe

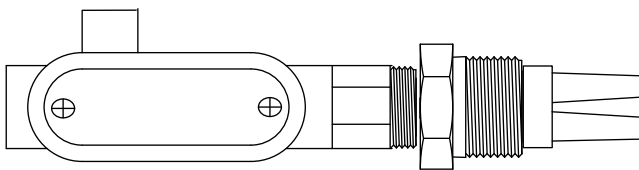

BE-32 Conductivity Probe

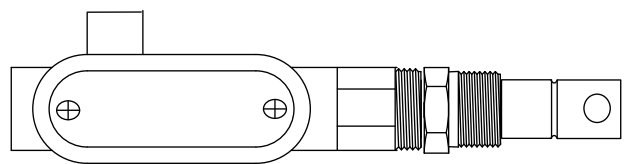

## Typical Boiler Continuous Sampling Installation

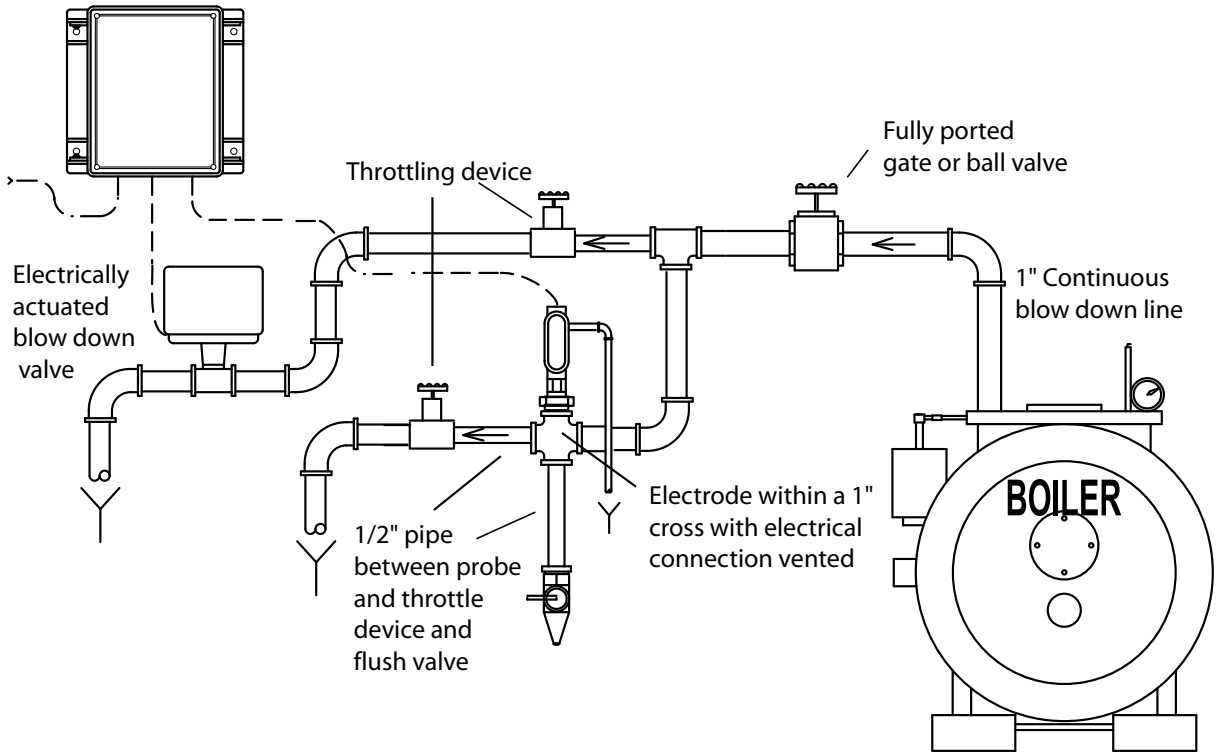

**Warning - Do not use on bottom blowdown lines, only continuous or surface blowdown lines.**

## Typical Boiler Timed Sampling Installation

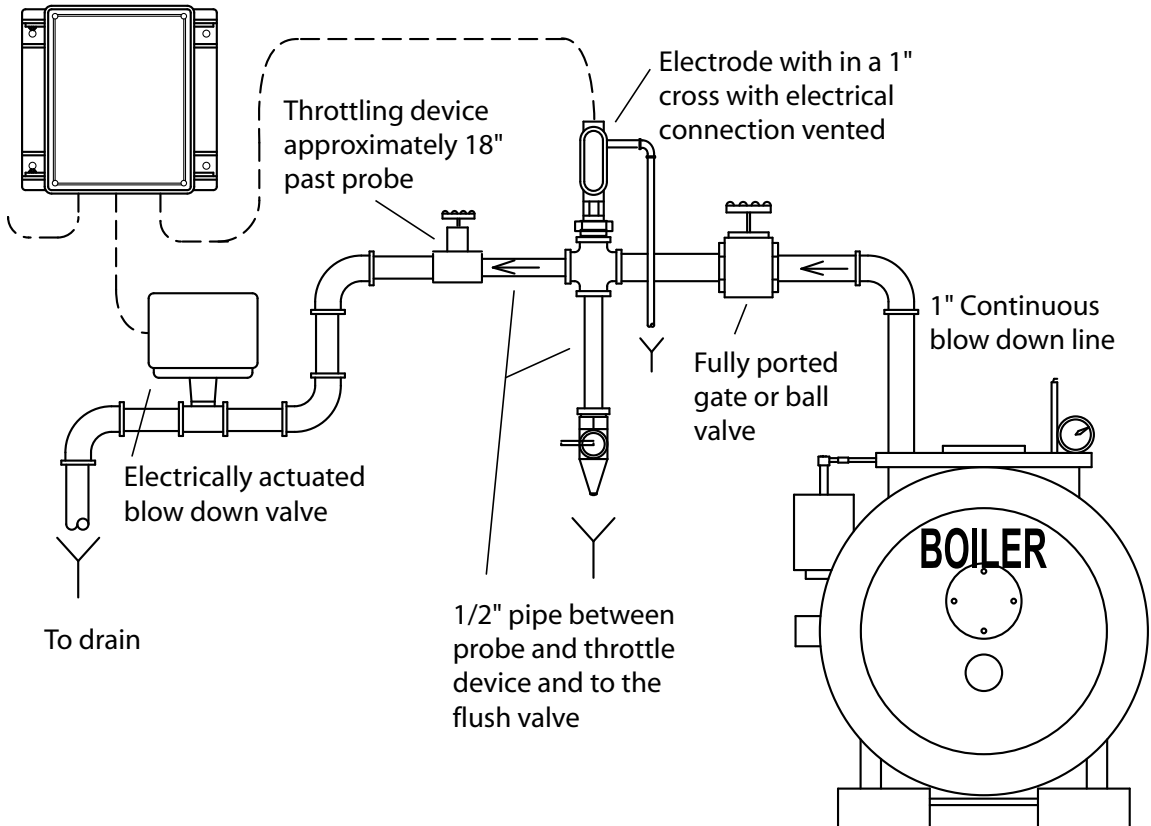

**Warning - Do not use on bottom blowdown lines, only continuous or surface blowdown lines.**

### III. Front Panel Description

There are some variations of the front panel based on the model number and the probe function of the controller.

**ANALOG or LCD DISPLAY:** The large display provides a constant reading of the probe input. The set point is displayed when the set point read button is pushed in.

**LO/HI SCALE switch:** Only on analog conductivity displays to select the Low or High conductivity scale as the operating range.

**Notes:**

- 1. Unit is factory calibrated for the high scale.**
- 2. Check calibration when changing scales.**

**POWER LED:** Lights whenever power is supplied to the controller.

**CALIBRATION:** Used to change the current probe reading. To use, adjust the screw to the left or right to achieve the reading you desire.

**Note:** **There is a 2-3 second delay for change to be displayed.**

**TEST button:** Used to test the control circuit. When the switch is pushed and held in the down position the control output will be tested.

**SET POINT READ button:** Depress push button switch to read the set point.

**SET POINT ADJ screw:** Used in conjunction with READ switch to adjust set point of controller.

**CONTROL LED:** Lights whenever the probe reading crosses the set point and the control relay turns on.

**TIMER KNOBS “optional”:** Knobs for adjusting optional digital timers for chemical feed, limit or boiler sampling.

**RESET:** Resets and starts chemical feed or sample timers (if present). On pH/ORP units press Reset and Read together to set differential.

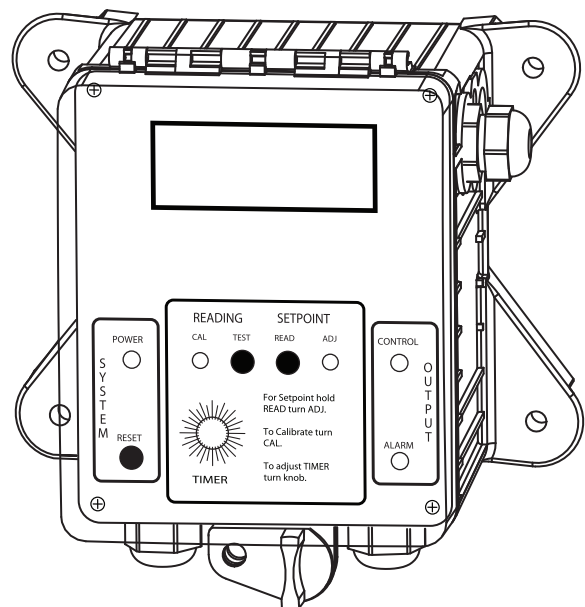
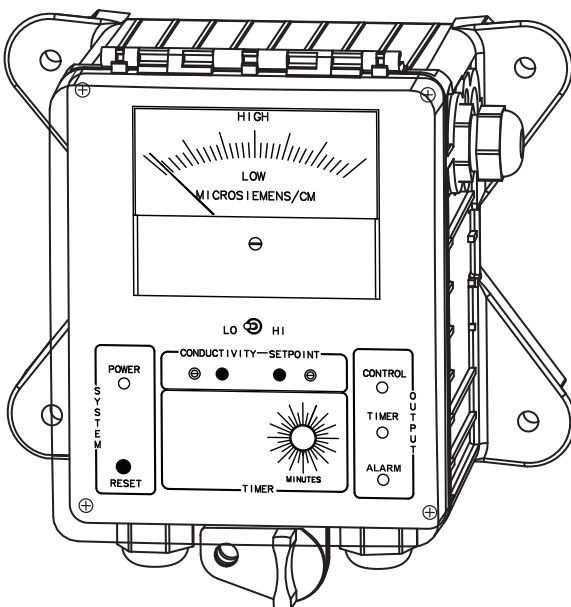

## IV. Start Up

### Conductivity Cooling Tower

#### A. System Start Up

1. Install the unit per the instructions on Page 6 of this manual.
2. Connect all externally controlled devices and supply power to the unit.
3. Choose the scale to be used and place the scale switch in the proper position.
4. Calibrate the unit. If you change scales, always re-calibrate.
5. Set the desired Set Point at which you want to keep the conductivity of the system.

**Note:** The high and low alarm levels are fixed at 20% above & below the setpoint, and as such, changing the setpoint, low alarm, or high alarm values changes all three parameters at once. K-option controllers have independently adjustable alarm settings that aren't affected by setpoint adjustments. K-option shown on page 5.

#### B. Setting Optional Feed Timers

Your unit may have one or none of several different chemical feed timers. See model numbering on page 3 to determine timer type. See page 4 for a description of your timer's operation.

1. Turn the timer's knob to the desired time. LCD units show the selected time on the display.

#### C. Calibration

Before attempting to calibrate the unit, ensure that the electrode is properly cleaned. Use a reliable hand held tester like the Advantage model HT-3P to determine the conductivity of the system water. Insure the sample used is the same as the water going through the probe tee.

##### Analog Meter and LCD models

1. Adjust the calibration screw until the desired reading is displayed.

**Note:** There is a 2 second delay before adjustments made to the set point and / or calibration are reflected on the display.

### Conductivity Boiler

#### A. System Start Up

1. Pick a scale that will position the set point as close as possible to the middle of the scale.
2. Check the unit's calibration against a reliable tester. Adjust the calibration as needed by following the calibration instructions on page 12.
3. Set the desired Set Point at which you want to keep the conductivity in the boiler.

**Note:** The high and low alarm levels are fixed at 20% above & below the setpoint, and as such, changing the setpoint, low alarm, or high alarm values changes all three parameters at once. K-option controllers have independently adjustable alarm settings that aren't affected by setpoint adjustments. K-option shown on page 5.

4. Timed Sampling units, set the sample interval and duration timers to the desired values.
5. Sample and Hold units, turn dip switch 8 on (see page 5) and set hold and blowdown times then turn dip switch 8 off and set interval and duration.

## B. Setting the Sample Timers

Each application is different and will require some fine tuning of timer settings. However, some generalizations can be made:

1. The higher the blowdown requirement, the more frequent the sample intervals should be.
2. The farther the probe is located away from the boiler the longer the sample duration must be. This is because the electrode must be at the same temperatures as the boiler water to provide an accurate reading. The further the probe from the boiler, the longer it takes to heat up.
3. A good starting place is to set the sample interval at 1 hour and the duration at 1 minute.

### Fine tuning the sample timer

**Interval setting** - If the boiler only blows down during sampling intervals (never exceeds the set point) the interval is too frequent. If the blowdown continues for long periods following programmed sample periods the interval is too long.

**Duration setting** - The ideal duration setting is the amount of time required for the conductivity reading to stabilize. This stabilization occurs when the temperature of the electrode equals the temperature of the boiler water. The timer is adjustable from 0-155 seconds.

To determine the ideal setting, turn the DURATION dial to maximum. Press and release the RESET switch to open the blowdown valve. Observe the action of the meter or digital display. When the reading stops increasing, the temperature is stabilized. When the reading achieved becomes stable record the elapsed time. This will become the DURATION SETTING.

### NOTES:

1. **Flashing occurs due to insufficient back pressure at the electrode. It occurs because the orifice size is too large, or the valve open setting is too great. Flashing is indicated by an unstable conductivity reading. If flashing occurs, reduce the size of the flow control opening.**
2. **Blowdown rate should be high enough to allow sufficient blowdown, but not too high as to allow the conductivity reading to change too rapidly. Several adjustments to the blowdown rate may be required before the ideal setting is achieved.**

## C. Calibration Instructions

Be sure the electrode is clean before calibration.

1. Use a reliable test method to determine the conductivity of the boiler water.
2. Open the blowdown valve by forcing the sample duration timer on or pressing the TEST switch. This will start a flow of water past the electrode. If the sample probe reading is higher than the set point, the valve will stay open after the button is released. If reading is below set point, the button must remain pressed to keep the valve open.
3. After blowing down for 1 to 2 minutes, adjust the CALIBRATE screw to make meter readings the same as your test sample reading.

**Example:** You test boiler water and the reading is 3500 microSiemens, put the HI LO scale switch to HI scale and adjust CALIBRATE screw until meter reads 3500 microSiemens.

### NOTES:

1. **Always calibrate to the same temperature type of tested sample. If a hot sample is used, always use a hot sample.**
2. **If the analog needle is jumping dramatically, calibration will not be stable.**
3. **If you change scales you will need to check calibration. A different resistor is being referenced from one scale to the other.**

## pH and ORP

### A. System Start Up

1. Install the unit per the instructions on Page 6 of this manual.
2. Connect all externally controlled devices and supply power to the unit.
3. Calibrate the unit.
4. Set the desired Set Point at which you want to keep the system water.

**Note:** The high and low alarm levels are fixed at 20% above & below the setpoint, and as such, changing the setpoint, low alarm, or high alarm values changes all three parameters at once. K-option controllers have independently adjustable alarm settings that aren't affected by setpoint adjustments. K-option shown on page 5.

5. Set feed limit timer knob to desired time to prevent chemical overfeed. Set to 0 to disable limit timer and output will stay on until the differential is met.

### B. Calibration

Before attempting to calibrate the unit, insure that electrode is properly cleaned .

1. Use a reliable test method to determine the pH or ORP of the system water. Insure that the sample used is the same as what is going through the probe tee. If a tester is not available, a solution of known value can be used. Do not allow the electrode to touch the bottom of the sample container or to dry out.
2. Turn the calibration screw left or right until the reading on the meter is the same as the reading achieved in step 1.

**Note: pH / ORP units have a test switch on the back of the front panel to calibrate to 7.0 pH or 0 mV.**

## V. Maintenance

The only required maintenance for normal uninterrupted operation of your Advantage 2EZ controller is cleaning the electrode. After initial start up, it is a good idea to clean the electrode weekly until a schedule based on need has been developed. Since each application is unique, it is difficult to estimate the required frequency of cleaning. The first cleaning should take place after about one week of the system being on line.

### Conductivity Electrode Cleaning Procedure

To determine the required cleaning frequency, record the reading on the controller before the electrode is removed for cleaning. After cleaning, record the new reading. If a change is observed in the two readings, the electrode was dirty. The more significant the change, the dirtier the electrode. If no change occurs, cleaning needs to be done less often.

1. Record the current conductivity reading.
2. Turn off water flow through the electrode loop, bleed pressure from the line and remove electrode.
3. Use a clean cloth and a mild cleaning solution to remove loose dirt etc., from the flat surface of the electrode.
4. If deposits such as scale are attached to the electrode surface, use a more aggressive cleaning approach. There are several ways to do this, the preferred method is the one that is easiest for the user.

- a. Use a mild acid solution to dissolve deposits.
  - b. Use a pocket knife with a flat blade to scrape across the probe surface *perpendicular* to the carbons.
  - c. Lay a piece of sandpaper ( 200 grit or finer ) on a flat surface such as a bench top. The electrode can then be “sanded” to remove stubborn deposits.
5. Reinstall the electrode in the system. After the reading stabilizes, calibrate the unit to a reliable test reading.

Many times an electrode can appear to be clean, but the unit still cannot be calibrated. If this is the case use the TEST switch to determine that the unit itself is working properly.

If the controller checks out, but still cannot be calibrated, use one of the more aggressive electrode cleaning procedures listed in step 4 above. Recheck the calibration after completion of this procedure. If no change was observed in the reading, replace the electrode. If a change occurred but the unit still will not calibrate, repeat procedure as many times as necessary.

### **pH & ORP Electrode Cleaning Procedure**

Slow response or non-reproducible measurements are signs that the electrode has become coated, clogged or damaged. The pH/ORP glass is susceptible to coating by many substances. The speed of response, normally 95% of the reading in less than 20 seconds, is dramatically degraded when the glass is coated.

The reference gel is used up under normal operations after about 12 months. Harsh installations will reduce probe life and drying out of probe will cause failure.

1. Remove the electrode from the system.
2. Spray with water and/or detergent, using a soft brush to dislodge any particulate matter.
3. Visually inspect the electrode for signs of damage.
4. Calibrate the electrode.
5. Replace into the system, taking care to avoid torsion on the cable.

## **VII. Troubleshooting**

The 2EZ controllers are designed to provide many years of trouble free operation. Should a problem occur, refer to the following chart to help identify the problem. If problem persists, contact our customer service department with the model number and serial number of unit for free factory technical assistance at 800-743-7431.

<b>SYMPTOM</b>	<b>POSSIBLE CAUSE</b>	<b>SOLUTION</b>
False reading	Bad or dirty electrode Out of calibration Wrong dip switch settings	Clean as needed Calibrate unit Adjust dip switch settings (pg. 5)
Will not calibrate	Dirty electrode Faulty electrode Faulty wiring to electrode Out of calibration Wrong dip switch settings	Clean electrode Replace controller or electrode as needed. Calibrate unit Adjust dip switch settings (pg. 5)
No system power	Power source Fuse blown	Check power source Replace as needed (2 amp)
No output power	No flow	Clean or replace

## Adjusting the Differential

The 2EZ controllers have a user adjustable differential, or dead band, around the set point to prevent relay chatter. The potentiometer is mounted on the control card for conductivity units (see page 5) and on the front panel of pH/ORP units.

On conductivity units remove the four panel screws to access. This is a multi-turn pot (you may need to turn it several times to change the differential to its maximum range which is half of the scale). To see what the unit's differential is see Dip Switch instructions on page 5.

## VII. Advantage Controls' Product Warranty

Advantage Controls warrants control systems of its manufacture to be free of defects in material or workmanship. Liability under this policy extends for 24 months from date of installation. Liability is limited to repair or replacement of any failed equipment or part proven defective in material or workmanship upon manufacturer's examination. Removal and installation costs are not included under this warranty. Manufacturer's liability shall never exceed the selling price of equipment or part in question.

Advantage disclaims all liability for damage caused by its products by improper installation, maintenance, use or attempts to operate products beyond their intended functionality, intentionally or otherwise, or any unauthorized repair. Advantage is not responsible for damages, injuries or expense incurred through the use of its products.

The above warranty is in lieu of other warranties, either expressed or implied. No agent of ours is authorized to provide any warranty other than the above.

### 30 Day Billing Memo Policy

Advantage Controls maintains a unique factory exchange program to ensure uninterrupted service with minimum downtime. If your in warranty controller malfunctions, call 1-918-686-6211, and provide our technician with Model and Serial Number information. If we are unable to diagnose and solve your problem over the phone, a fully warranted replacement unit will be shipped, usually within 48 hours, on a 30 Day Billing Memo.

This service requires a purchase order and the replacement unit will be billed at current list price for that model less any applicable resale discount. Upon return of your old unit, credit will be issued to your account if the unit is in warranty. If the unit is out of warranty or the damage not covered, a partial credit will be applied based upon a prorated replacement price schedule dependent on the age of the unit. Any exchange covers only the controller or pump. **Electrodes, liquid ends and other external accessories are not included.**

### FCC Warning

This equipment generates and uses radio frequency energy and if not installed and used properly, that is, in strict accordance with the manufacturer's instruction, may cause interference to radio communications. It has been type tested and found to comply with the limits for a class A computing device pursuant to subpart J of part 15 of FCC Rules, which are designed to provide reasonable protection against such interference when operated in a commercial or industrial environment. Operation of this equipment in a residential area is likely to cause interference in which case the user, at his own expense, will be required to take whatever measures necessary to correct the interference.